

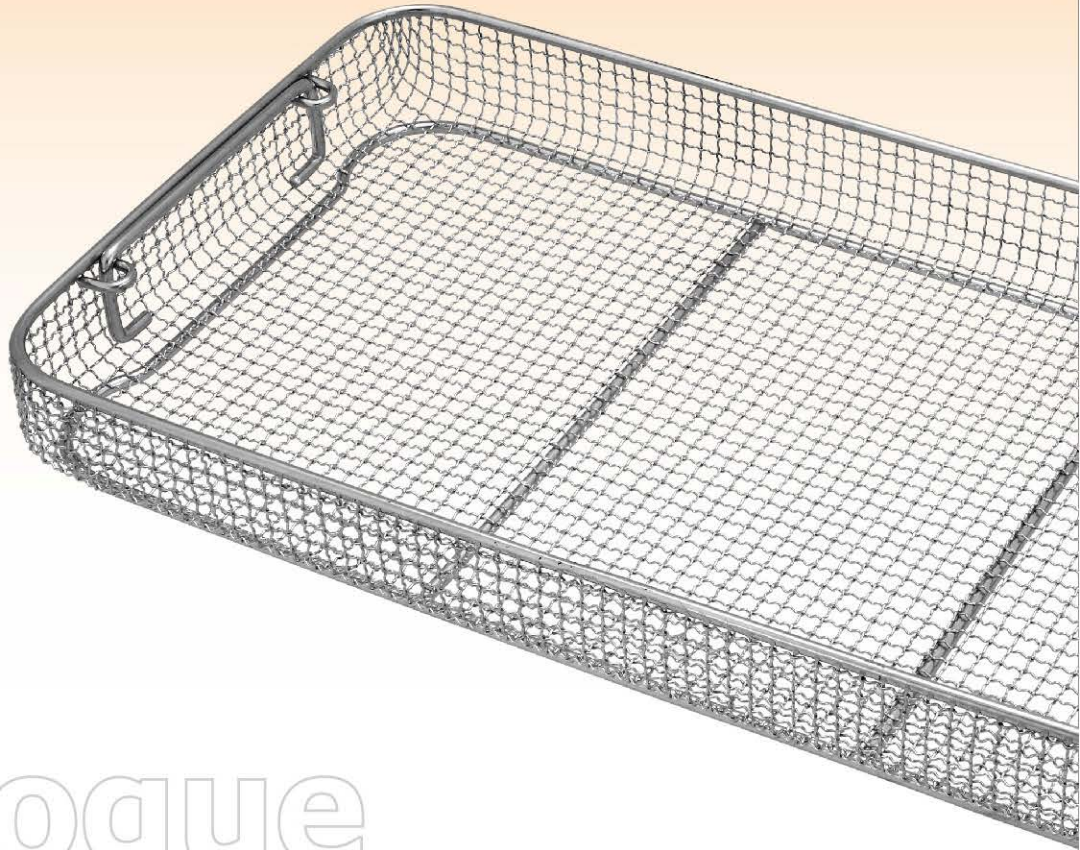

www.daudjeemfg.com



2017 Catalogue

Sterilization Baskets & Trays

DAUD JEE MFG.CO

Handling + Sterilization

Introduction

Daud Jee offers comprehensive range of surgical instruments baskets and trays. Our instruments trays and baskets provide a high degree of Protection of storage, transportation and sterilizing to costly surgical instruments. Available in various Sizes & Designs that accommodate a wide range of Surgical instruments.

Daud Jee products are now being introduced in the World market fairly extensively. For that matter We are backed by ISO 9001-2008, ISO 13485, 2003 Certification, CE & FDA. We invite you to consider this Source for your future requirements.

Made from high quality stainless steel providing both strength and Durability at an affordable price.

Designed with rounded corners and edges to avoid common problems of wraps being torn by sharp edges and also eliminating the possibility user injury.

EXCEPTIONALLY ROBUST AND RESISTANT TO ACCIDENTAL DAMAGE

Manufacturers of a comprehensive range of Surgical Instruments sterilizing baskets including Side Perforated Baskets, Wire Mesh Baskets, Fine Mesh Baskets, Endoscopy Baskets, and customised baskets for holding scopes.

We can custom make Din, scope and Mesh baskets to suit your needs. This may be for delicate Instruments, such as cataract or phaco sets. These can be made depending on the requirements of the surgeon and what they require in their set. We also manufacture custom baskets for holding expensive scopes in place.

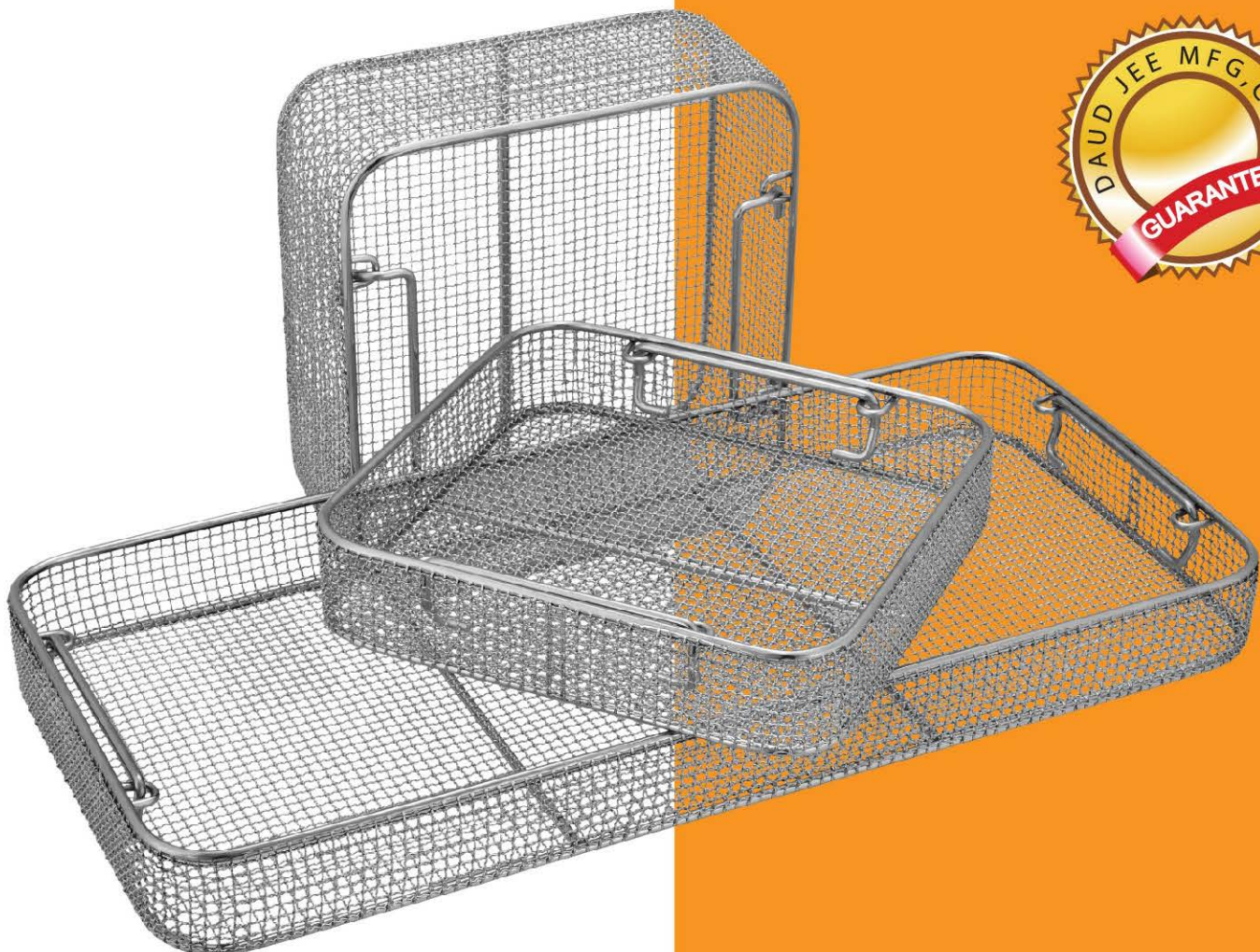

DAUD JEE MFG.CO
Handling + Sterilization
www.daudjeemfg.com

PRODUCT GUARANTEE

DAUD JEE MFG.CO, guarantees all its products against poor craftsmanship and material. Any item found defective will be repaired or replaced free of charge.

This guarantee does not cover any product which becomes defective through misuse, negligence or mishandling.



INDEX

Products

	Page
Side Perforated Basket Wire Base	01
Lids for Side Perforated Basket Wire Base	02
Side Perforated Basket Flat Base	03
Lid for Side Perforated Basket Flat Base	04
Standard Wire Mesh Basket	05
Lids for Standard Wire Mesh Basket	06
Crimped Wire Mesh Basket	07
Lids for Crimped Wire Mesh Basket	08
Classic Crimped Wire Mesh Basket	09
Fine Mesh Baskets with Lid	10
Micro Fine Mesh Baskets with Lid	11
Full Perforated Trays with Lid	12
Wire Net Baskets	13
Sterilie Goods Baskets	14
Baskets SPRI	15
Wire Racks	16
Endoscope Baskets	17-19
Micro Ophthalmic Baskets / Plastic Autoclave Trays	20
Instruments Cassettes	21-23
Micro Cassettes / Fixing Clamps	24
Implantology Cassettes	25-26
Bur Clips / Bur Holder Stand	27
Hospital Ware	28-31

INDEX

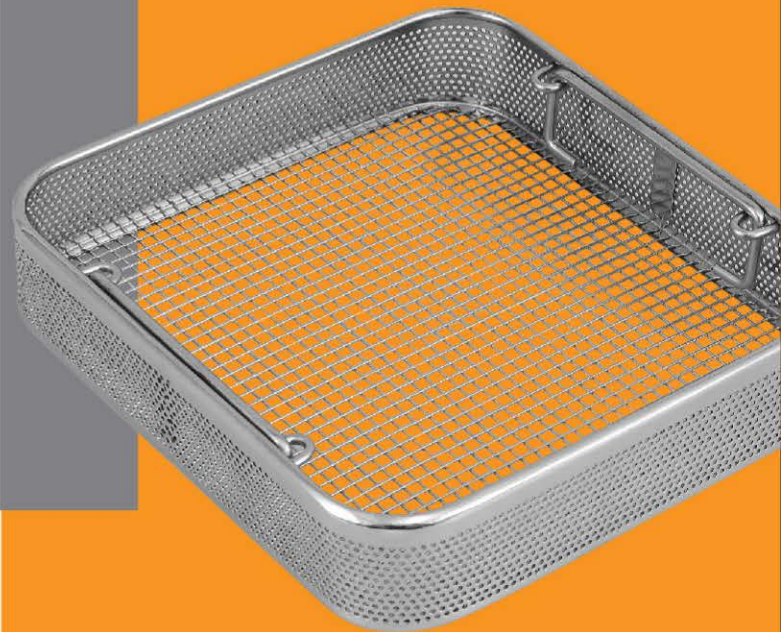

Side Perforated Basket Wire Base

The wire base is designed for quickly drying of the instruments after washing & sterilizing. Also used for handling & storage of instruments.

Side Perforated Basket Wire Base

Our side perforated baskets are:

- Manufactured in stainless steel grade AISI-304 .
- Electro-polished.
- Burr free to protect, wraps and eliminate user injury.
- Smooth round Edges.
- Side wall perforated to protect sharp instruments edges and tips from damage. The perforation hole size is 2.0 mm.
- Meet all requirements of automatic washing and sterilization of all kinds of instruments.
- Separate lids are available with single, double and detention frame.
- Inner mounted drop handles.
- Top and bottom frame diameter 5.0 mm.
- Base available in wire mesh with opening square 6.0 mm, wire diameter 1.2 mm.
- Stacking frame can also be available on request.

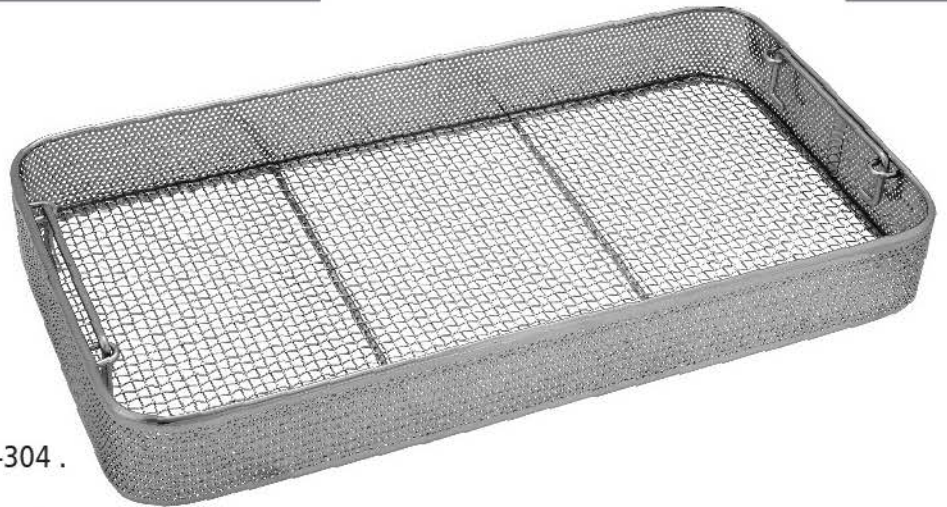

Smooth Round Edges

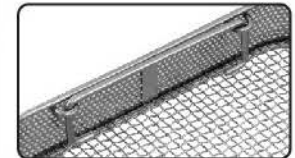

Inner Mounted Drop Handles



Item Code	Sizes in mm	Item Code	Sizes in mm
DJ-4610	240X120X30	DJ-4661	540X250X30
DJ-4611	240X120X50	DJ-4662	540X250X50
DJ-4612	240X120X60	DJ-4663	540X250X60
DJ-4608	240X120X70	DJ-4664	540X250X70
DJ-4609	240X120X100	DJ-4665	540X250X100
DJ-4607	240X250X30	DJ-4622	300x300x50
DJ-4613	240X250X50	DJ-4623	300x300x60
DJ-4615	240X250X60	DJ-4624	470x400x60
DJ-4616	240X250X70	DJ-4625	480x480x50
DJ-4617	240X250X100	DJ-4626	480x480x60
DJ-4656	405X250X30	DJ-4628	500x300x50
DJ-4657	405X250X50	DJ-4632	550x430x50
DJ-4658	405X250X60	DJ-4634	600x300x60
DJ-4659	405X250X70		
DJ-4660	405X250X100		
DJ-4606	480X250X30		
DJ-4618	480X250X50		
DJ-4619	480X250X60		
DJ-4620	480X250X70		
DJ-4621	480X250X100		

Many More sizes available on request

**Lid for perforated baskets
 (Single Frame)**

Item Code	Sizes in mm
DJ-4635	240X120
DJ-4636	240X250
DJ-4642	405x250
DJ-4637	480X250
DJ-4643	540x250
DJ-4638	300X300
DJ-4639	480X480
DJ-4640	500X300
DJ-4641	600X300



Many More sizes available on request

**Lid for perforated baskets
 (Double Frame)**

Item Code	Sizes in mm
DJ-4635D	240x120
DJ-4636D	240X250
DJ-4642D	405x250
DJ-4637D	480X250
DJ-4643D	540x250
DJ-4638D	300X300
DJ-4639D	480X480
DJ-4640D	500X300
DJ-4641D	600X300

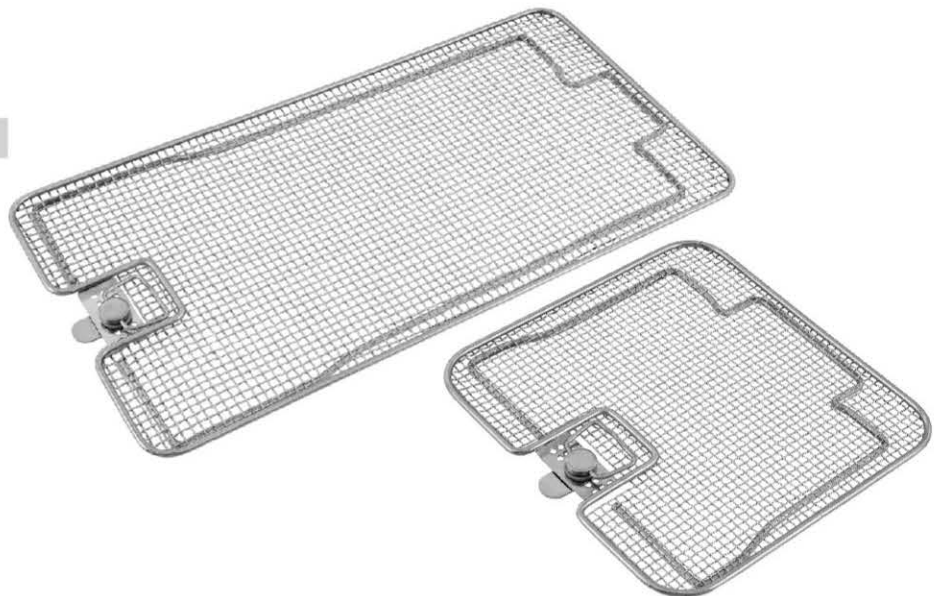

Many More sizes available on request

**Lid for perforated baskets
 (Detention Frame)**

Item Code	Sizes in mm
DJ-4635DT	240X120
DJ-4636DT	240X250
DJ-4642DT	405x250
DJ-4637DT	480X250
DJ-4643DT	540x250
DJ-4638DT	300X300
DJ-4639DT	480X480
DJ-4640DT	500X300
DJ-4641DT	600X300

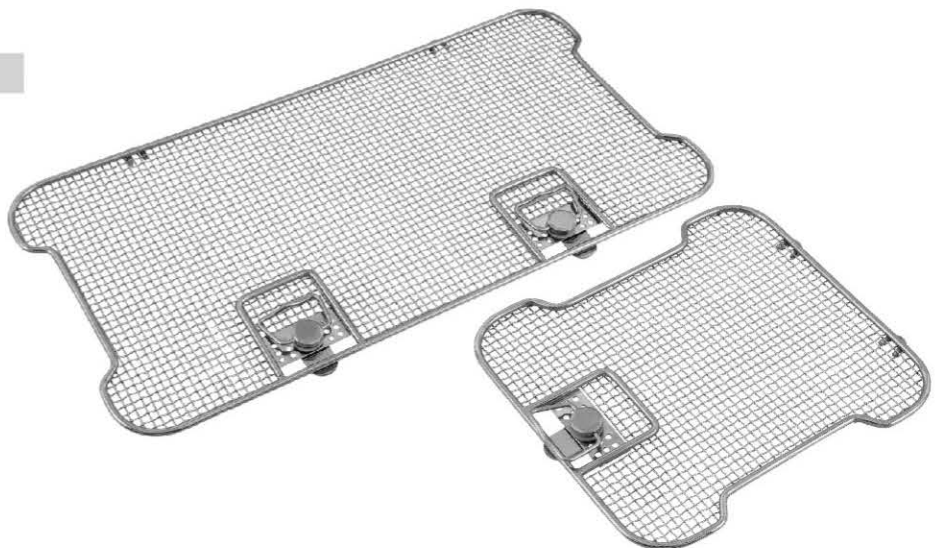

Many More sizes available on request

Side Perforated Basket Flat Base

The flat base is designed for quickly drying of the instruments after washing & sterilizing. Also used for handling & storage of instruments.

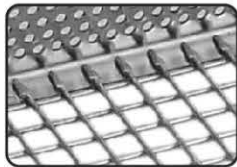

Flat base (Inner Side)

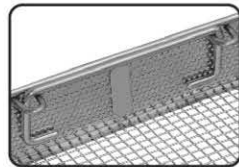

Inner mounted drop handle

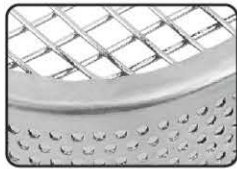

Flat base (Outer Side)



Smooth round edges

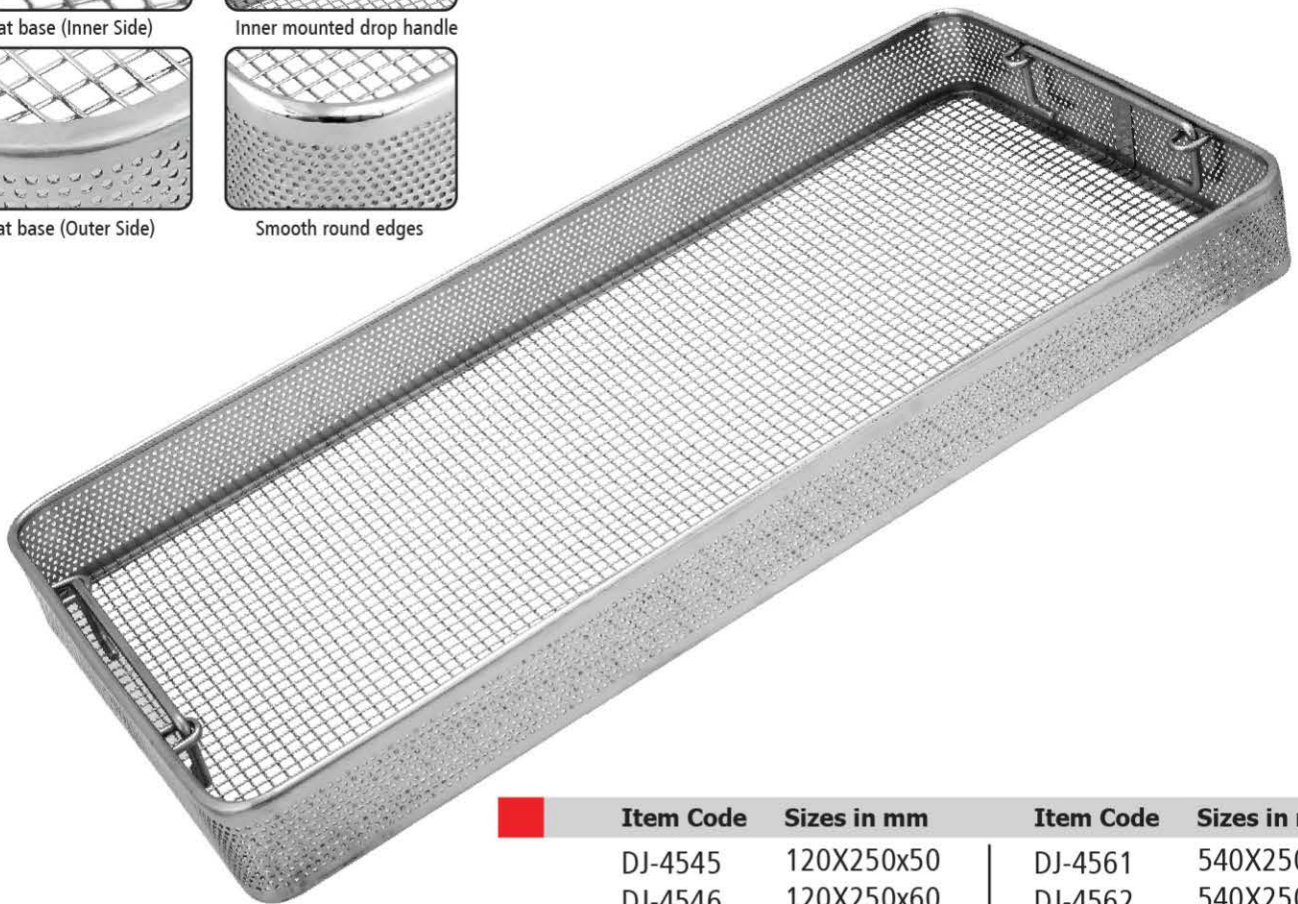

Item Code	Sizes in mm	Item Code	Sizes in mm
DJ-4545	120X250x50	DJ-4561	540X250x50
DJ-4546	120X250x60	DJ-4562	540X250x60
DJ-4547	120X250x70	DJ-4563	540X250x70
DJ-4548	120X250x100	DJ-4564	540X250x100
DJ-4549	240x250x50	DJ-4565	480X360x50
DJ-4550	240x250x60	DJ-4566	480X360x60
DJ-4551	240x250x70	DJ-4567	480X360x70
DJ-4552	240x250x100	DJ-4568	480X360x100
DJ-4553	405X250x50	DJ-4569	480x480x50
DJ-4554	405X250x60	DJ-4570	480x480x60
DJ-4555	405X250x70	DJ-4571	480x480x70
DJ-4556	405X250x100	DJ-4572	480x480x100
DJ-4557	480x250x50		
DJ-4558	480x250x60		
DJ-4559	480x250x70		
DJ-4560	480x250x100		

Many More sizes available on request

Side Perforated Basket Flat Base

Our side perforated baskets are:

- Manufactured in stainless steel grade AISI-304 .
- Electro-polished.
- Burr free to protect, wraps and eliminate user injury.
- Smooth round Edges.
- Side wall perforated to protect sharp instruments edges and tips from damage. The perforation hole size is 2.0 mm.
- Meet all requirements of automatic washing and sterilization of all kinds of instruments.
- Separate lids are available with double frame.
- Inner mounted drop handles.
- Top frame diameter 5.0 mm.
- Flat base basket available in welded mesh with opening square 6.0mm, wire diameter 1.2 mm.
- Stacking frame can also be available on request.



Lid for perforated baskets (Double Frame)

Item Code	Sizes in mm
DJ-4582	120X250
DJ-4583	240X250
DJ-4584	405X250
DJ-4585	480X250
DJ-4586	540X250
DJ-4587	480X360
DJ-4588	480X480

Many More sizes available on request

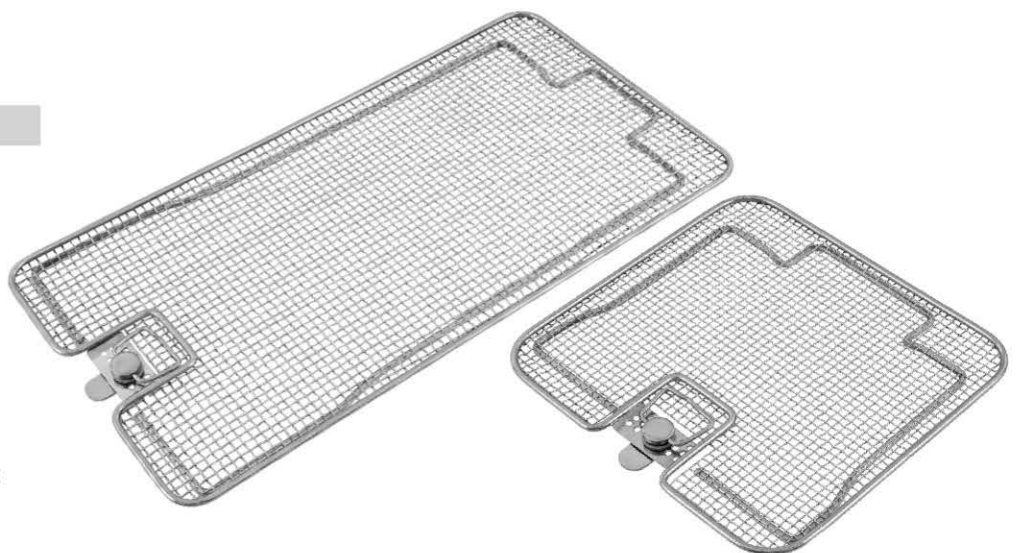

Standard Wire Mesh Baskets

Standard Wire Mesh Baskets are used for Surgical Instruments Washing, Disinfection, Sterilization, Storage and Handling.

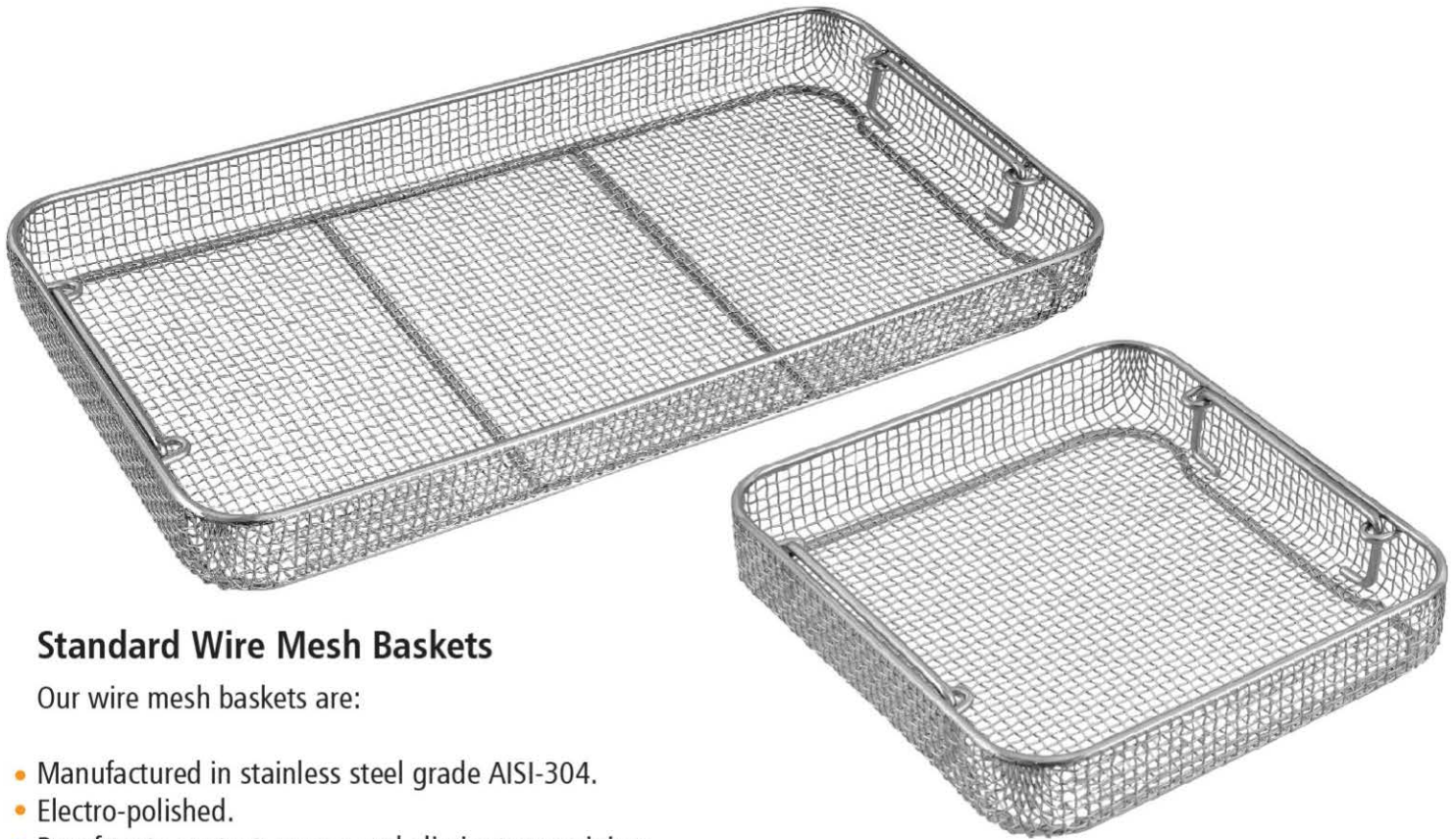

Standard Wire Mesh Baskets

Our wire mesh baskets are:

- Manufactured in stainless steel grade AISI-304.
- Electro-polished.
- Burr free to protect, wraps and eliminate user injury.
- Meet all requirements of automatic washing and sterilization of all kinds of instruments.
- Separate lids are available with single, double and detention frame.
- Available in drop and folding handles.
- Top and bottom frame diameter 5.0 mm.
- Wire mesh with opening square 4.5 mm, wire diameter 1.00 mm.
- Baskets are stackable.

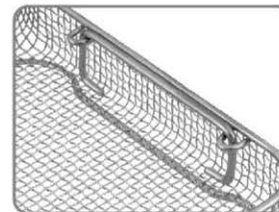

Inner Mounted Drop Handles

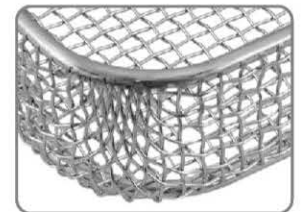

Corner Edge

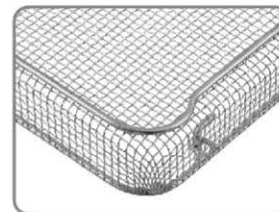

Bottom Stacking Frame

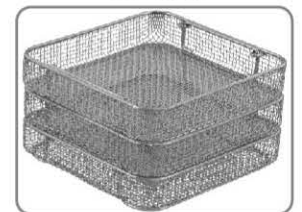

Stackability

Item Code	Sizes in mm
DJ-4401	105X240X30
DJ-4402	105X240X50
DJ-4403	105X240X60
DJ-4404	105X240X70
DJ-4405	105X240X100
DJ-4406	240X240X30
DJ-4407	240X240X50
DJ-4408	240X240X60
DJ-4409	240X240X70
DJ-4410	240X240X100
DJ-4411	240X250X30
DJ-4412	240X250X50
DJ-4413	240X250X60
DJ-4414	240X250X70
DJ-4415	240X250X100
DJ-4416	250X250X30
DJ-4417	250X250X50

Item Code	Sizes in mm
DJ-4418	250X250X60
DJ-4419	250X250X70
DJ-4420	250X250X100
DJ-4421	405X250X30
DJ-4422	405X250X50
DJ-4423	405X250X60
DJ-4424	405X250X70
DJ-4425	405X250X100
DJ-4426	480X240X30
DJ-4427	480X240X50
DJ-4428	480X240X60
DJ-4429	480X240X70
DJ-4430	480X240X100

Many More sizes available on request

Item Code	Sizes in mm
DJ-4431	480X250X30
DJ-4432	480X250X50
DJ-4433	480X250X60
DJ-4434	480X250X70
DJ-4435	480X250X100
DJ-4436	480X480X30
DJ-4437	480X480X50
DJ-4438	480X480X60
DJ-4439	480X480X70
DJ-4440	480X480X100
DJ-4441	540X250X30
DJ-4442	540X250X50
DJ-4443	540X250X60
DJ-4444	540X250X70
DJ-4445	540X250X100

**Lids for Wire Mesh Baskets
 (Single Frame)**

Item Code	Sizes in mm
DJ-4455	105X240
DJ-4456	240X240
DJ-4457	240X250
DJ-4458	250X250
DJ-4459	405X250
DJ-4460	480X240
DJ-4461	480X250
DJ-4462	480X480
DJ-4463	540X250



Many More sizes available on request

**Lids for Wire Mesh Baskets
 (Double Frame)**

Item Code	Sizes in mm
DJ-4455D	105X240
DJ-4456D	240X240
DJ-4457D	240X250
DJ-4458D	250X250
DJ-4459D	405X250
DJ-4460D	480X240
DJ-4461D	480X250
DJ-4462D	480X480
DJ-4463D	540X250

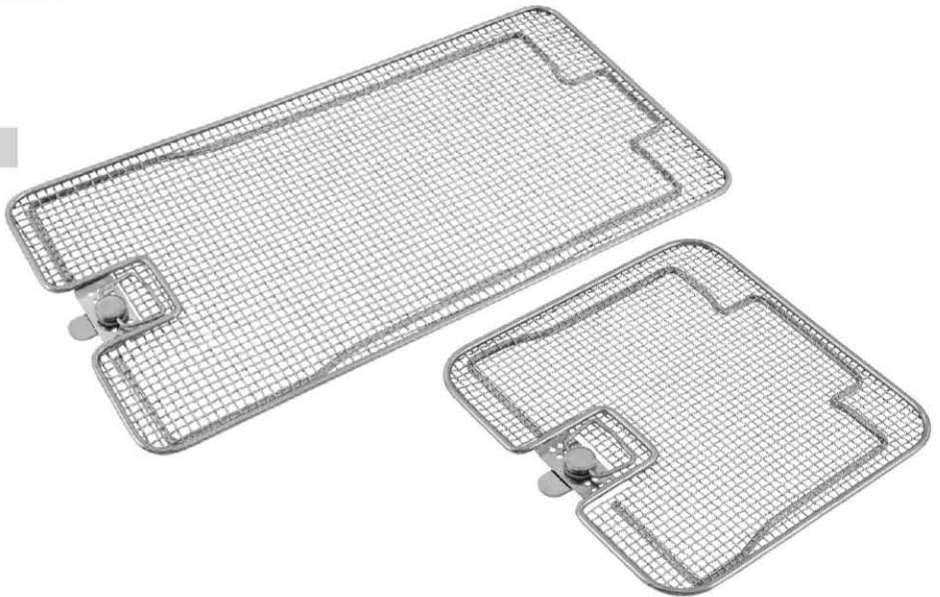

Many More sizes available on request

**Lids for Wire Mesh Baskets
 (Detention Frame)**

Item Code	Sizes in mm
DJ-4455DT	105X240
DJ-4456DT	240X240
DJ-4457DT	240X250
DJ-4458DT	250X250
DJ-4459DT	405X250
DJ-4460DT	480X240
DJ-4461DT	480X250
DJ-4462DT	480X480
DJ-4463DT	540X250

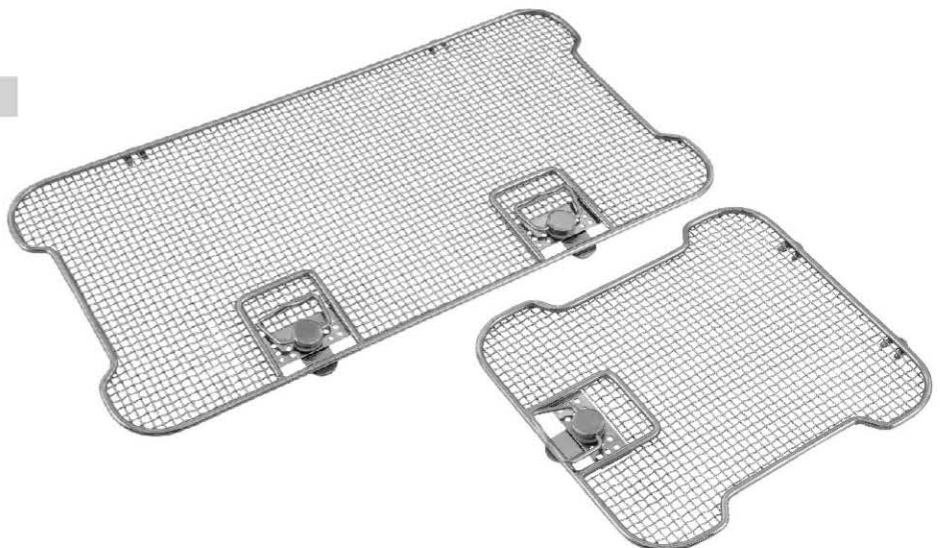

Many More sizes available on request

Crimped Wire Mesh Baskets

Crimped Wire Mesh Baskets are used for Surgical Instruments Washing, Disinfection, Sterilization, Storage and Handling.

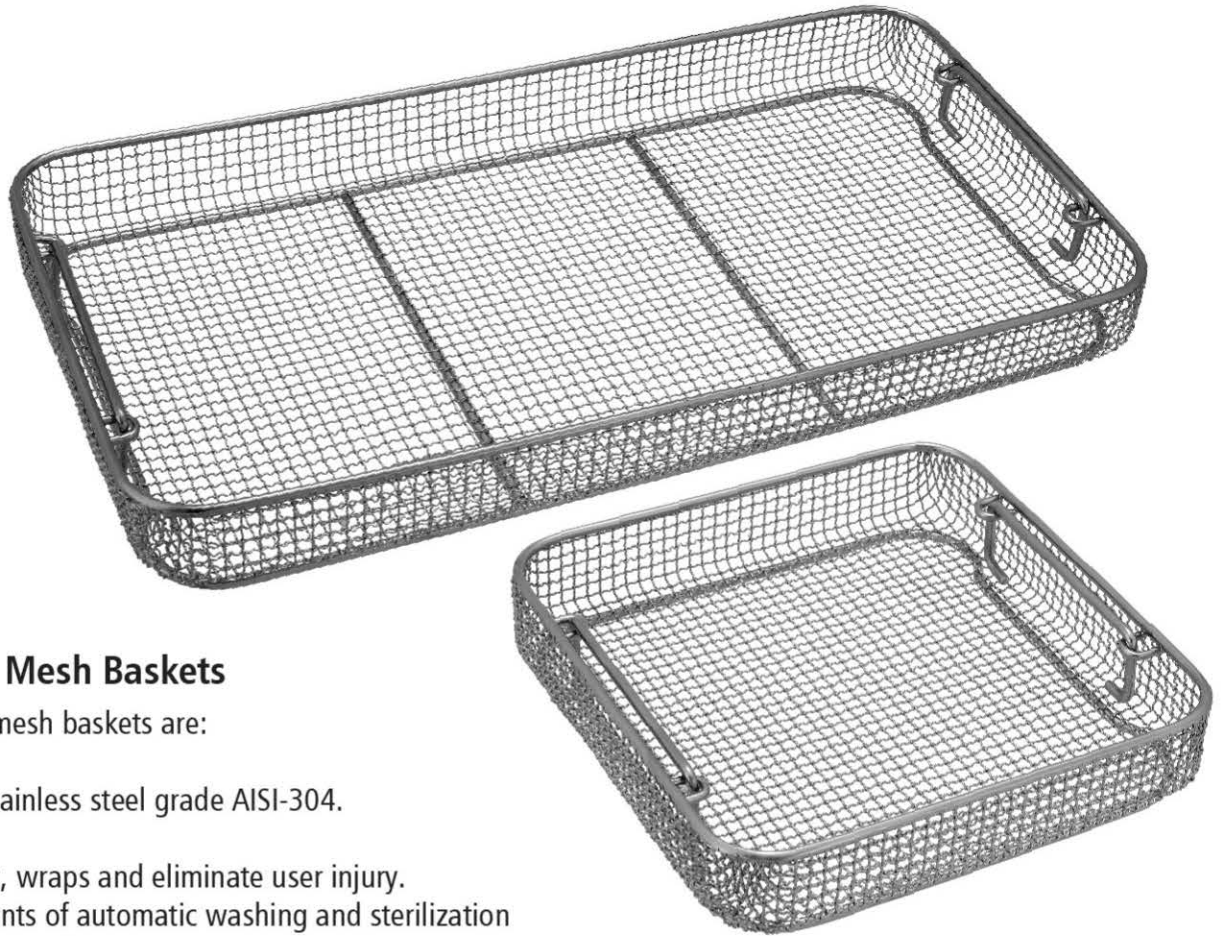

Crimped Wire Mesh Baskets

Our crimped wire mesh baskets are:

- Manufactured in stainless steel grade AISI-304.
- Electro-polished.
- Burr free to protect, wraps and eliminate user injury.
- Meet all requirements of automatic washing and sterilization of all kinds of instruments.
- Separate lids are available with single, double and detention frame.
- Available in tilted and drop handles.
- Top and bottom frame diameter 5.0 mm.
- Crimped mesh with opening square 5.0 mm, wire diameter 0.9 mm.
- Baskets are stackable.

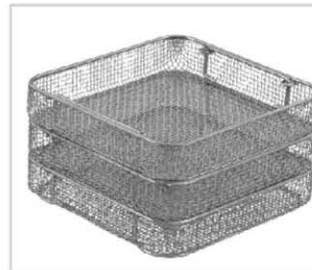

Stackability



Bottom Stacking Frame



Tilted Handle

Item Code	Sizes in mm
DJ-4401CW	105X240X30
DJ-4402CW	105X240X50
DJ-4403CW	105X240X60
DJ-4404CW	105X240X70
DJ-4405CW	105X240X100
DJ-4406CW	240X240X30
DJ-4407CW	240X240X50
DJ-4408CW	240X240X60
DJ-4409CW	240X240X70
DJ-4410CW	240X240X100
DJ-4411CW	240X250X30
DJ-4412CW	240X250X50
DJ-4413CW	240X250X60
DJ-4414CW	240X250X70
DJ-4415CW	240X250X100
DJ-4416CW	250X250X30
DJ-4417CW	250X250X50

Item Code	Sizes in mm
DJ-4418CW	250X250X60
DJ-4419CW	250X250X70
DJ-4420CW	250X250X100
DJ-4421CW	405X250X30
DJ-4422CW	405X250X50
DJ-4423CW	405X250X60
DJ-4424CW	405X250X70
DJ-4425CW	405X250X100
DJ-4426CW	480X240X30
DJ-4427CW	480X240X50
DJ-4428CW	480X240X60
DJ-4429CW	480X240X70
DJ-4430CW	480X240X100

Item Code	Sizes in mm
DJ-4431CW	480X250X30
DJ-4432CW	480X250X50
DJ-4433CW	480X250X60
DJ-4434CW	480X250X70
DJ-4435CW	480X250X100
DJ-4436CW	480X480X30
DJ-4437CW	480X480X50
DJ-4438CW	480X480X60
DJ-4439CW	480X480X70
DJ-4440CW	480X480X100
DJ-4441CW	540X250X30
DJ-4442CW	540X250X50
DJ-4443CW	540X250X60
DJ-4444CW	540X250X70
DJ-4445CW	540X250X100

Many More sizes available on request

**Lid for Crimped Wire Mesh Baskets
(Single Frame)**

Item Code	Sizes in mm
DJ-4455CW	105X240
DJ-4456CW	240X240
DJ-4457CW	240X250
DJ-4458CW	250X250
DJ-4459CW	405X250
DJ-4460CW	480X240
DJ-4461CW	480X250
DJ-4462CW	480X480
DJ-4463CW	540X250



Many More sizes available on request

**Lid for Crimped Wire Mesh Baskets
(Double Frame)**

Item Code	Sizes in mm
DJ-4455DCW	105X240
DJ-4456DCW	240X240
DJ-4457DCW	240X250
DJ-4458DCW	250X250
DJ-4459DCW	405X250
DJ-4460DCW	480X240
DJ-4461DCW	480X250
DJ-4462DCW	480X480
DJ-4463DCW	540X250

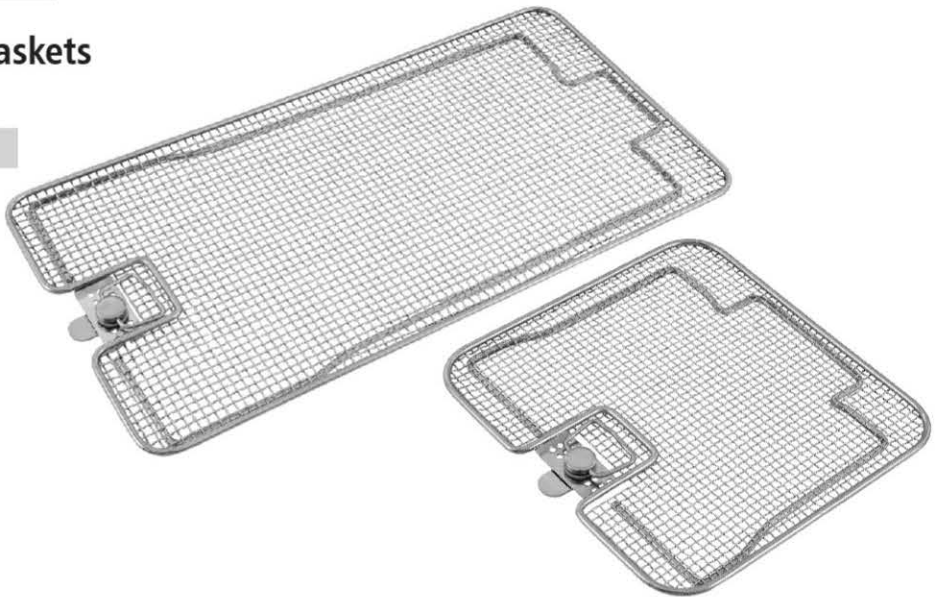

Many More sizes available on request

**Lid for Crimped Wire Mesh Baskets
(Detention Frame)**

Item Code	Sizes in mm
DJ-4455DTCW	105X240
DJ-4456DTCW	240X240
DJ-4457DTCW	240X250
DJ-4458DTCW	250X250
DJ-4459DTCW	405X250
DJ-4460DTCW	480X240
DJ-4461DTCW	480X250
DJ-4462DTCW	480X480
DJ-4463DTCW	540X250

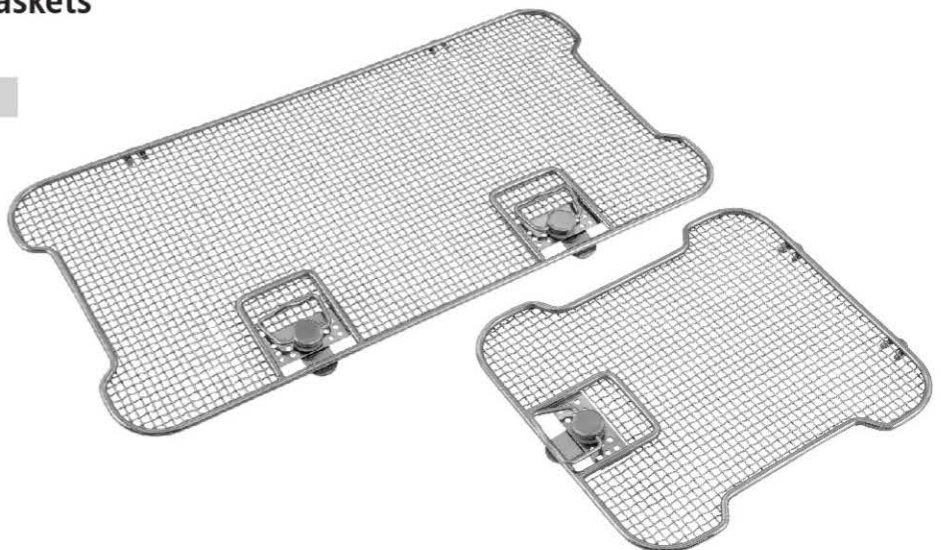

Many More sizes available on request

Classic Crimped Wire Mesh Baskets

Classic Crimped Wire Mesh Baskets are used for Surgical Instruments Washing, Disinfection, Sterilization, Storage and Handling.

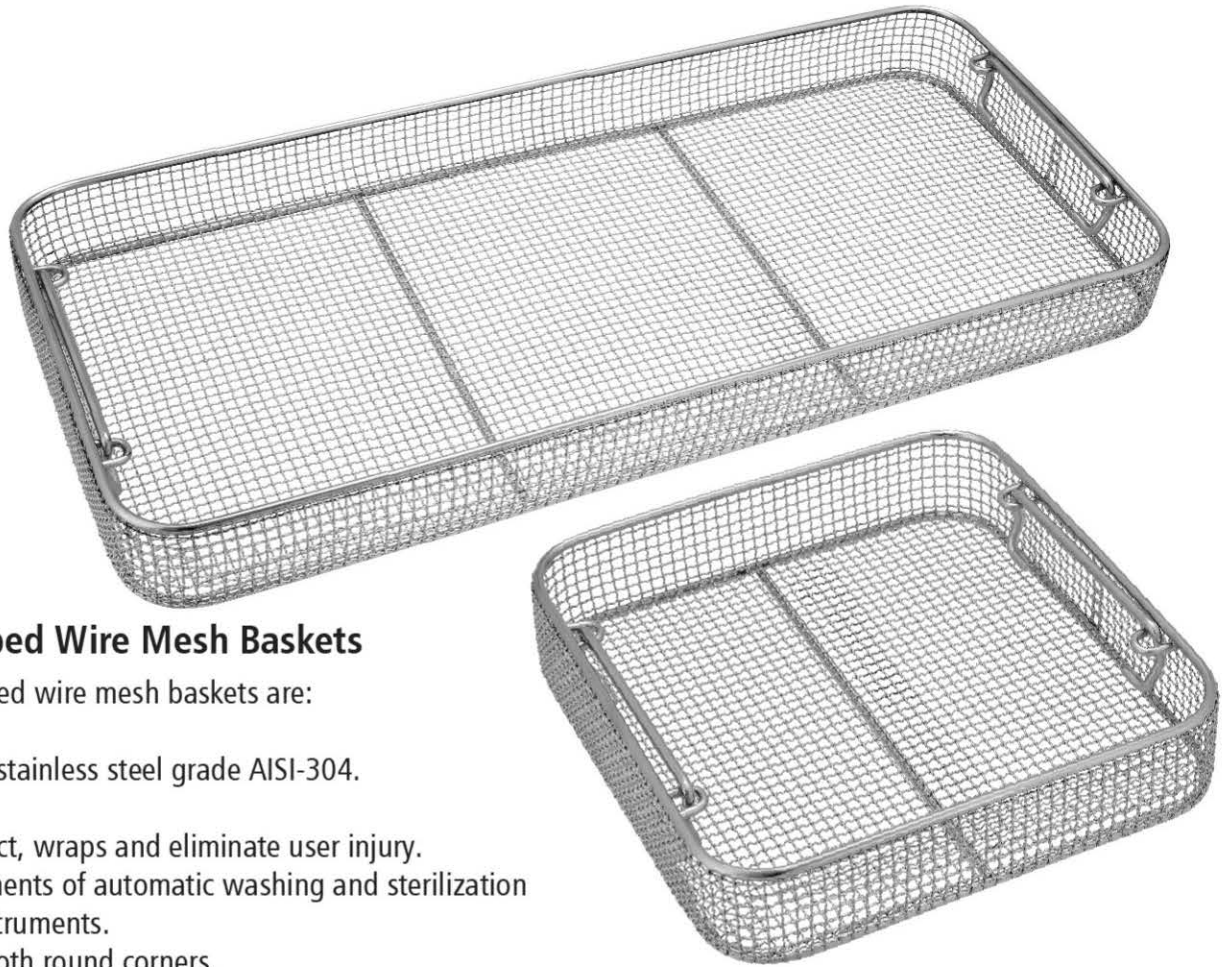

Classic Crimped Wire Mesh Baskets

Our Classic crimped wire mesh baskets are:

- Manufactured in stainless steel grade AISI-304.
- Electro-polished.
- Burr free to protect, wraps and eliminate user injury.
- Meet all requirements of automatic washing and sterilization of all kinds of instruments.
- Straight and smooth round corners.
- Available in tilted and drop handles.
- Top and bottom frame diameter 5.0 mm.
- Crimped mesh with opening square 6.0 mm, wire diameter 1.0 mm.



Smooth and Straight Corner

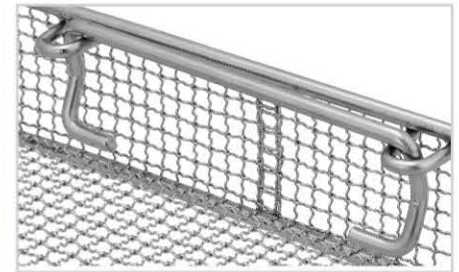

Tilted Handle

Item Code	Sizes in mm
DJ-4401ER	105X240X30
DJ-4402ER	105X240X50
DJ-4403ER	105X240X60
DJ-4404ER	105X240X70
DJ-4405ER	105X240X100
DJ-4406ER	240X240X30
DJ-4407ER	240X240X50
DJ-4408ER	240X240X60
DJ-4409ER	240X240X70
DJ-4410ER	240X240X100
DJ-4411ER	240X250X30
DJ-4412ER	240X250X50
DJ-4413ER	240X250X60
DJ-4414ER	240X250X70
DJ-4415ER	240X250X100
DJ-4416ER	250X250X30
DJ-4417ER	250X250X50

Item Code	Sizes in mm
DJ-4418ER	250X250X60
DJ-4419ER	250X250X70
DJ-4420ER	250X250X100
DJ-4421ER	405X250X30
DJ-4422ER	405X250X50
DJ-4423ER	405X250X60
DJ-4424ER	405X250X70
DJ-4425ER	405X250X100
DJ-4426ER	480X240X30
DJ-4427ER	480X240X50
DJ-4428ER	480X240X60
DJ-4429ER	480X240X70
DJ-4430ER	480X240X100

Many More sizes available on request

Item Code	Sizes in mm
DJ-4431ER	480X250X30
DJ-4432ER	480X250X50
DJ-4433ER	480X250X60
DJ-4434ER	480X250X70
DJ-4435ER	480X250X100
DJ-4436ER	480X480X30
DJ-4437ER	480X480X50
DJ-4438ER	480X480X60
DJ-4439ER	480X480X70
DJ-4440ER	480X480X100
DJ-4441ER	540X250X30
DJ-4442ER	540X250X50
DJ-4443ER	540X250X60
DJ-4444ER	540X250X70
DJ-4445ER	540X250X100

Fine Mesh Baskets With Lid
 Fine Mesh Baskets With Lid Use For Micro
 Surgical Instruments Washing, Sterilization
 And Storage.



Fine Mesh Baskets With Lid

Our Fine Mesh Baskets With Lid Are:

- Manufactured in stainless steel grade AISI-304.
- Electro-polished.
- Burr free to protect, wraps and eliminate user injury.
- Smooth round Edges.
- Top and lid frame wire diameter 3.5 mm and 04.0 mm (according to the size of baskets).
- Fine mesh with opening square 1.6 mm and wire diameter 0.7 mm
- Wire Locking Clip.

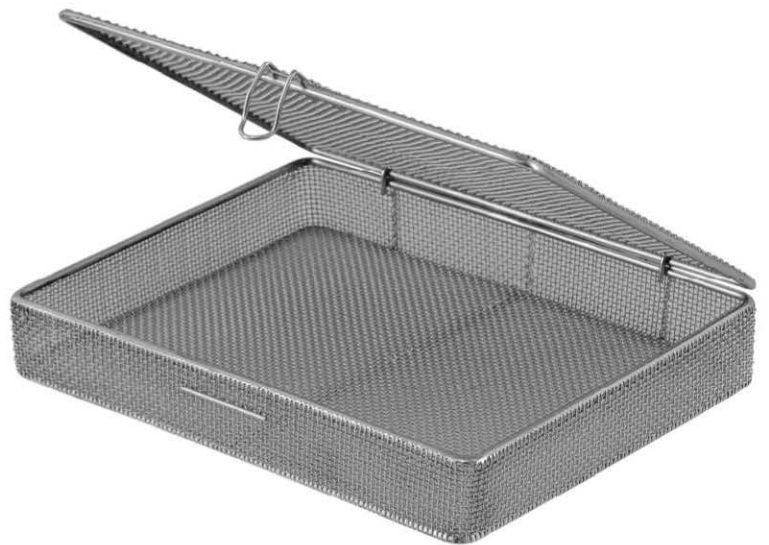

Item Code	Sizes in mm
DJ-4343	40X40x20
DJ-4344	70x70x30
DJ-4345	80x40x20
DJ-4346	80x40x30
DJ-4347	80x80x34
DJ-4348	80x80x40
DJ-4349	90x90x50
DJ-4350	150x110x20
DJ-4351	160x40x20
DJ-4352	105x70x25
DJ-4353	141x50x40
DJ-4354	150x50x35
DJ-4355	180x130x20
DJ-4356	190x85x100
DJ-4357	200x100x35

Item Code	Sizes in mm
DJ-4358	220x140x50
DJ-4359	210x170x20
DJ-4360	235x155x40
DJ-4361	240x90x40
DJ-4362	240x120x35
DJ-4363	275x175x35
DJ-4364	280x170x60
DJ-4365	250x200x20
DJ-4366	300x180x20
DJ-4367	200x110x40
DJ-4368	225x110x50
DJ-4369	235x120x60
DJ-4370	270x135x40
DJ-4371	280x145x50
DJ-4372	400x250x50

Many More sizes available on request

Micro Fine Mesh Baskets with Lid

Micro Fine Baskets are used for delicate Micro Instruments and parts washing, sterilization and storage.

Our Micro Fine Mesh Baskets are:

- Manufacture in stainless steel grade AISI-304.
- Top and lid frame wire diameter 3.5 mm
- Micro fine mesh with opening square 1.0 mm and wire diameter 5.0 mm
- Wire locking Clip.
- Electrolyte Polish.

Item Code	Sizes in mm
DJ-4343MM	40X40x20
DJ-4344MM	70x70x30
DJ-4345MM	80x40x20
DJ-4346MM	80x40x30
DJ-4347MM	80x80x34
DJ-4348MM	80x80x40
DJ-4349MM	90x90x50
DJ-4350MM	150x110x20
DJ-4351MM	160x40x20
DJ-4352MM	105x70x25
DJ-4353MM	141x50x40
DJ-4354MM	150x50x35
DJ-4355MM	180x130x20

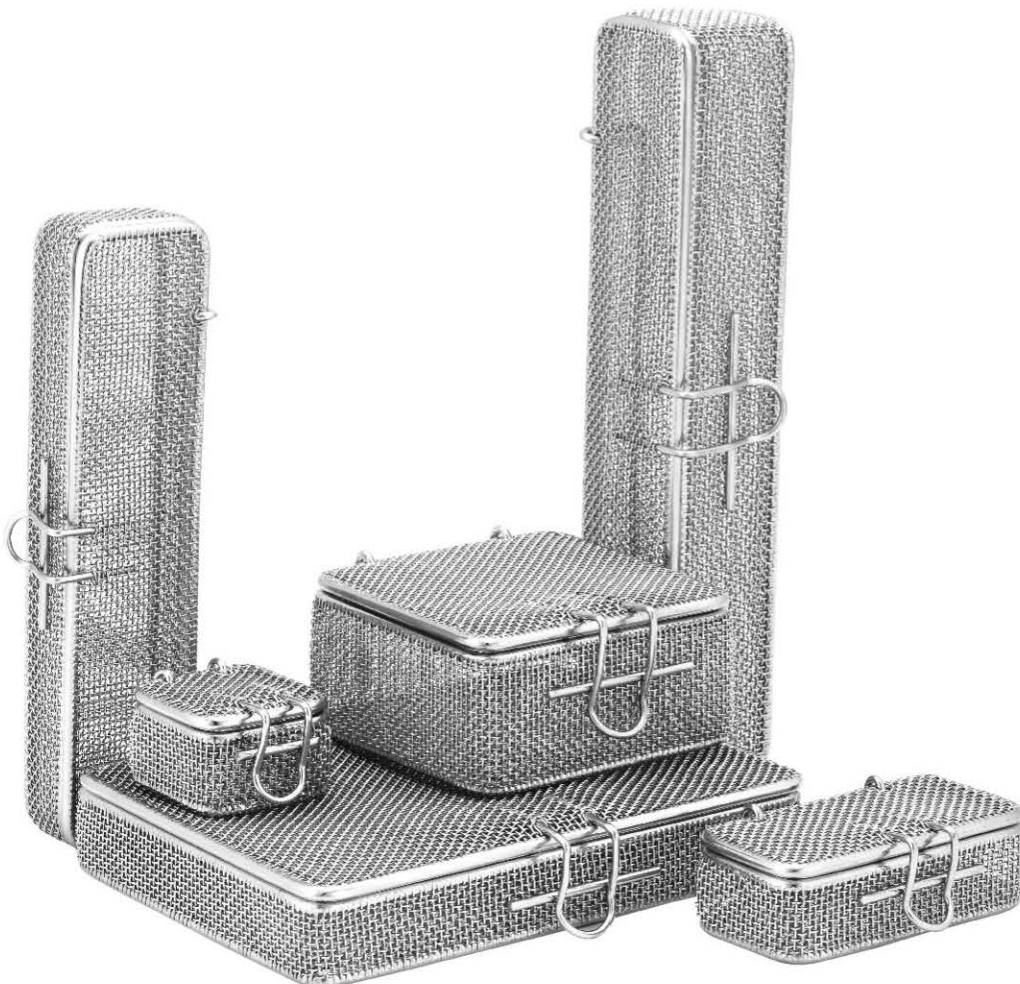

Full Perforated Trays with Lid
 Full Perforated Trays are used for delicate
 Micro Instruments and parts washing,
 sterilization and storage.

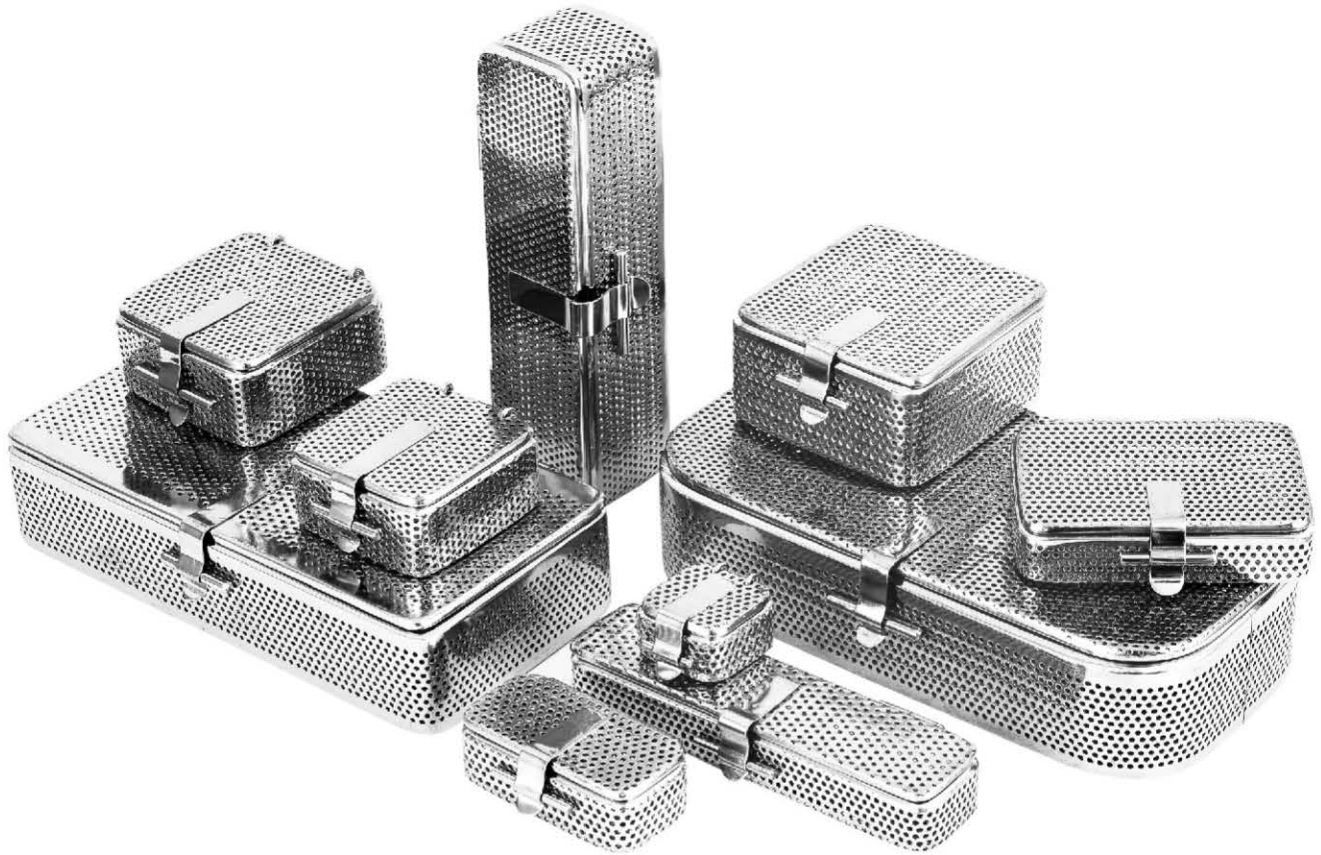

Our Full perforated trays are:

- Manufacture in stainless steel grade AISI-304.
- Electro Polished.
- Top and lid frame rod diameter 3.5 mm and 4.0 mm.
- Full wall perforation to protect sharp instruments edges and tips from damage. The perforation hole size is 2.0mm
- Smooth round edges.
- Sheet locking clip.
- Hinged Lids.

Item Code	Sizes in mm
DJ-2343	40X40X20mm
DJ-2344	70x70x30mm
DJ-2345	80x40x20mm
DJ-2346	80x40x30mm
DJ-2347	80x80x34mm
DJ-2348	80x80x40mm
DJ-2349	90x90x50mm
DJ-2350	150x110x20mm
DJ-2351	160x40x20mm
DJ-2352	105x40x20mm
DJ-2353	141x50x40mm
DJ-2354	150x50x35mm
DJ-2355	190x85x35mm
DJ-2356	200x100x35mm
DJ-2357	240x90x40mm
DJ-2358	200x110x40mm
DJ-2359	225x110x50mm

Wire Net Baskets

Used for Washing Instruments, Ultrasonic Cleaning & Sterilization.

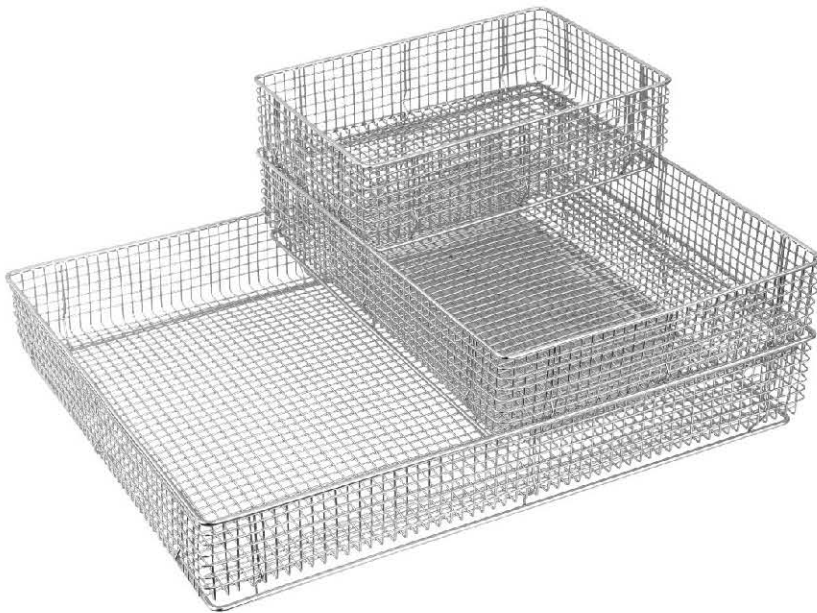

- Bottom frame fabricated to make space between instruments and working surface.
- Separate top cover available.
- Stackable.
- Top and bottom frame wire diameter 3.5 mm
Grid made with wire diameter 1.5 mm, opening square 6.0 mm
- Burr free smooth finish.
- Electrolyte Polish.



WIRE NET BASKET

Item Code	Sizes in mm
DJ-5000	250x170x70mm
DJ-5001	340x250x70mm
DJ-5002	450x340x70mm

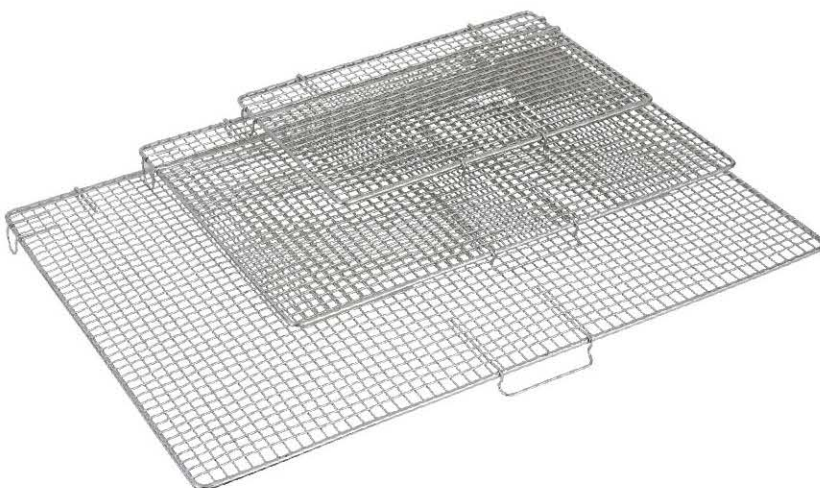

LID FOR WIRE NET BASKET

Item Code	Sizes in mm
DJ-5003	250x170mm
DJ-5004	340x250mm
DJ-5005	450x340mm

The standard baskets can be used for transportation, storage for all types of autoclaves. STE Sterilie Goods Baskets means the baskets made with continuous wire which provide maximum protection to user from being injured. The baskets are stackable and can also be mounted on the cart or wall with hooks.



Standard

Item Code	Sizes in mm	
DJ-5010	575x280x135	Standard
DJ-5011	575x280x265	Standard
DJ-5012	575x280x265	Front access



Front access

- Upper frame wire diameter 6.0 mm
- Frame wire diameter 3.0 mm
- Loops wire diameter 2.0 mm
- Base frame wire diameter 5.0 mm
- Electrolyte Polish and burr free smooth finish.

BASKET SPRI

The SPRI baskets are both stackable and nestable. Empty baskets take minimum storage space while nesting position. Stackable when placed on one another in opposite position.

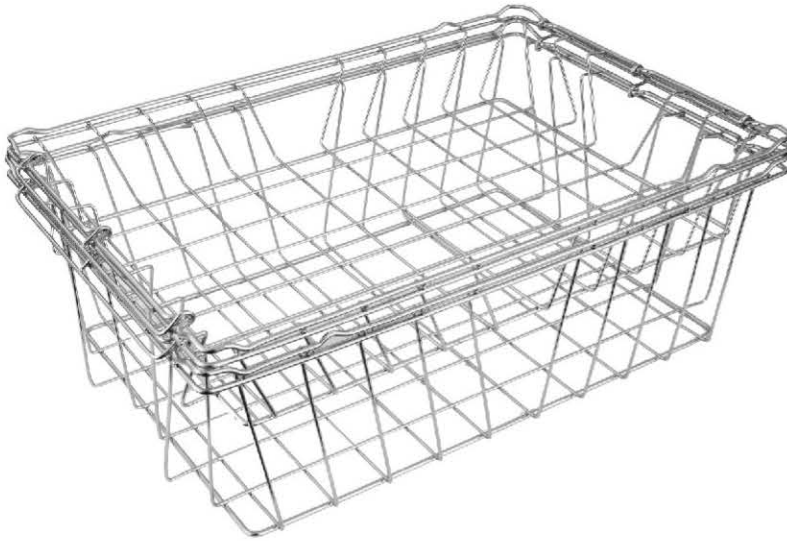

SPRI BASKETS (Double Frame with Folding Handle)

Item Code	Sizes in mm
DJ-6010	585x395x100
DJ-6011	585x395x195

- The SPRI baskets are both stackable and nestable.
- Stackable when the handles are folded into basket.
- Nestable when the handles are folded out.
- When the baskets are empty, hold minimum storage space in nesting position.
- Upper and lower frame wire diameter 5.0mm.
- Loops wire diameter 3.5mm
- Electrolyte polish and smooth finish.

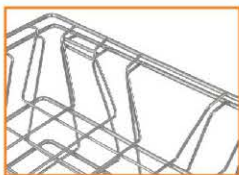
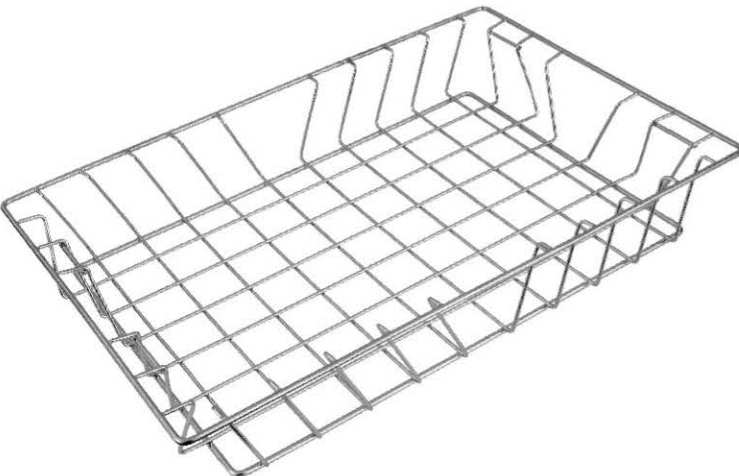
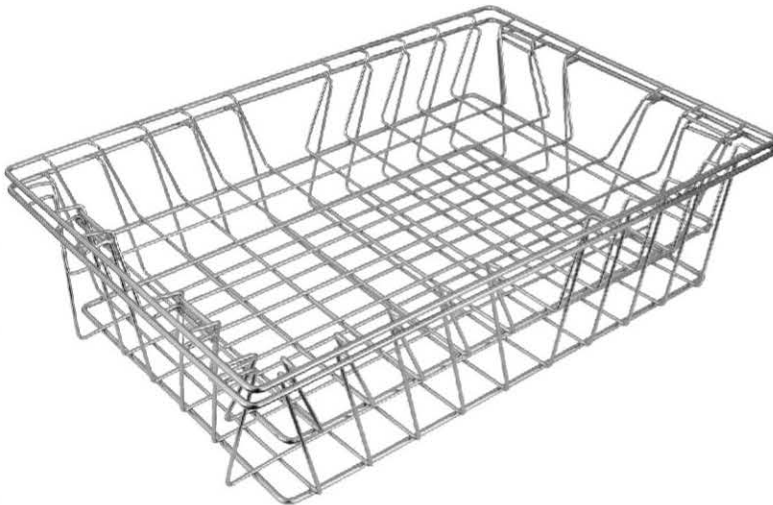

SPRI BASKETS (With Single Frame)

Item Code	Sizes in mm
DJ-6030	600x300x40
DJ-6031	600x300x50
DJ-6032	600x300x100
DJ-6033	600x300x130
DJ-6034	600x300x150
DJ-6035	600x300x180
DJ-6036	600x300x200
DJ-6037	600x400x100
DJ-6038	600x400x130
DJ-6039	600x400x150
DJ-6040	600x400x180
DJ-6041	600x400x200

- This type of baskets are also both nestable and stackable.
- Stackable when placed the basket on each other with opposite position.
- Nestable when placed in same position.
- Upper and lower frame wire diameter 6.0 mm.
- Loops wire diameter 4.0 mm.
- Electrolyte Polish.

Wire Racks

Wire Racks are used in trolleys and shelves system.



DAUD JEE MFG.CO

Handling + Sterilization

www.daudjeemfg.com

Item Code	Sizes in mm
-----------	-------------

DJ-6060	600x300
DJ-6061	600x400

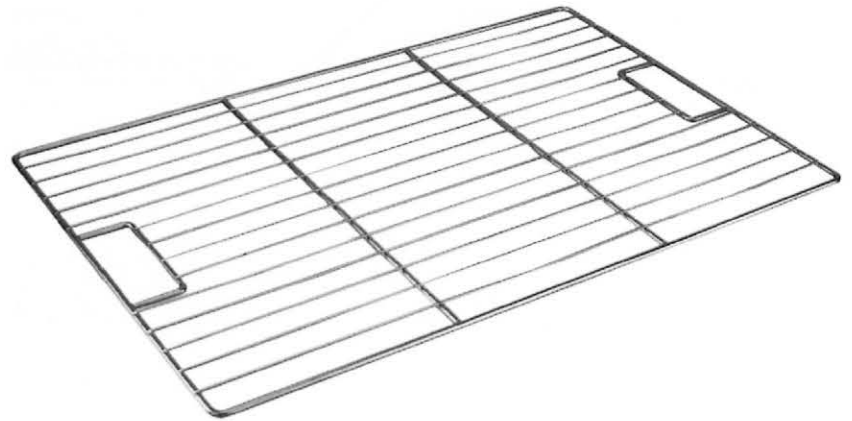

Wire diameter 6.0mm and 2.5mm

Item Code	Sizes in mm
-----------	-------------

DJ-6062	600x400x44
---------	------------

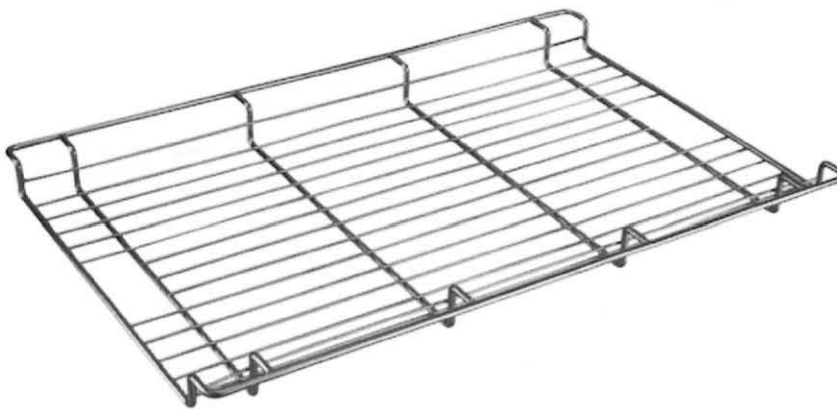

Wire diameter 6.0mm and 3.0mm

Item Code	Sizes in mm
-----------	-------------

DJ-6063	600x400x44
---------	------------

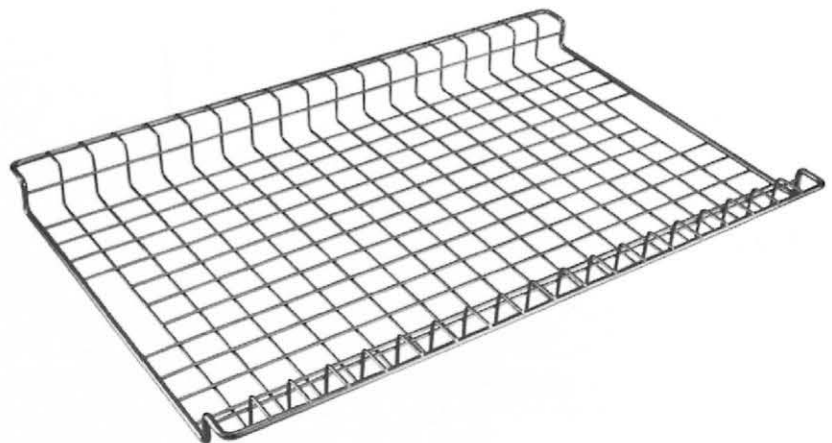

Wire diameter 6.0mm and 3.0mm

Endoscope Baskets

Endoscope Baskets provide the safety to costly endoscope during washing and sterilization processes. The silicon padding also provide protection to endoscope while handling and storage.

Item Code **Sizes in mm**
 DJ-4046 640x150x77

Small Lens Baskets



Locking Clip

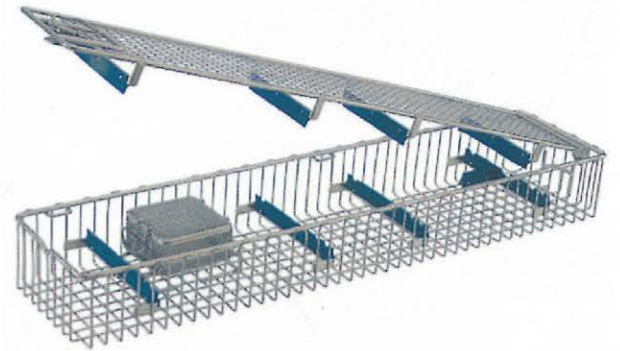

Item Code **Sizes in mm**
 DJ-4040 180X80X52
 DJ-4041 290X80X52

Arthroscope Basket



Item Code **Sizes in mm**
 DJ-4042 290X80X52



Item Code **Sizes in mm**
 DJ-4043 460x80x52

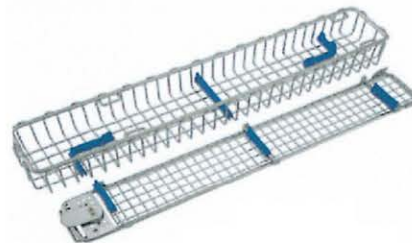

Item Code **Sizes in mm**
 DJ-4044 460x80x52

Endoscope Baskets

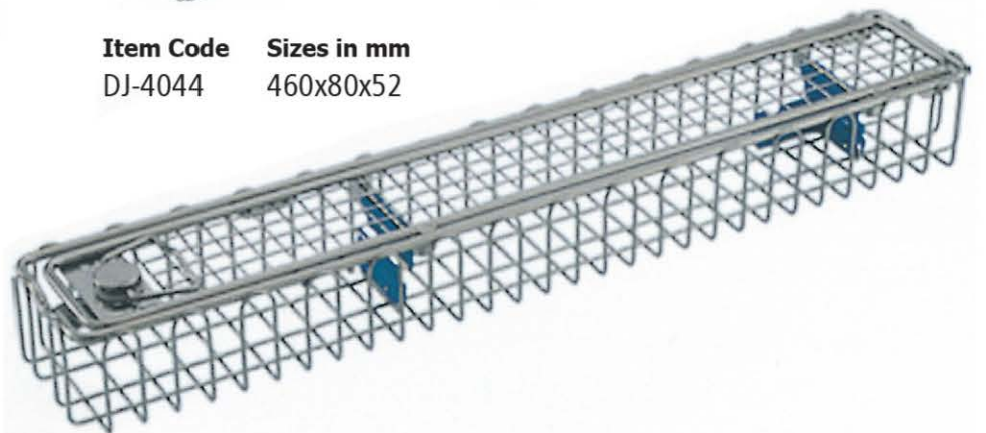

Endoscope Baskets

Endoscope Baskets provide the safety to costly endoscope during washing and sterilization processes. The silicon padding also provide protection to endoscope while handling and storage.

Item Code	Sizes in mm
DJ-4045	670x80x52
DJ-4047	600x80x52
DJ-4048	700x80x52

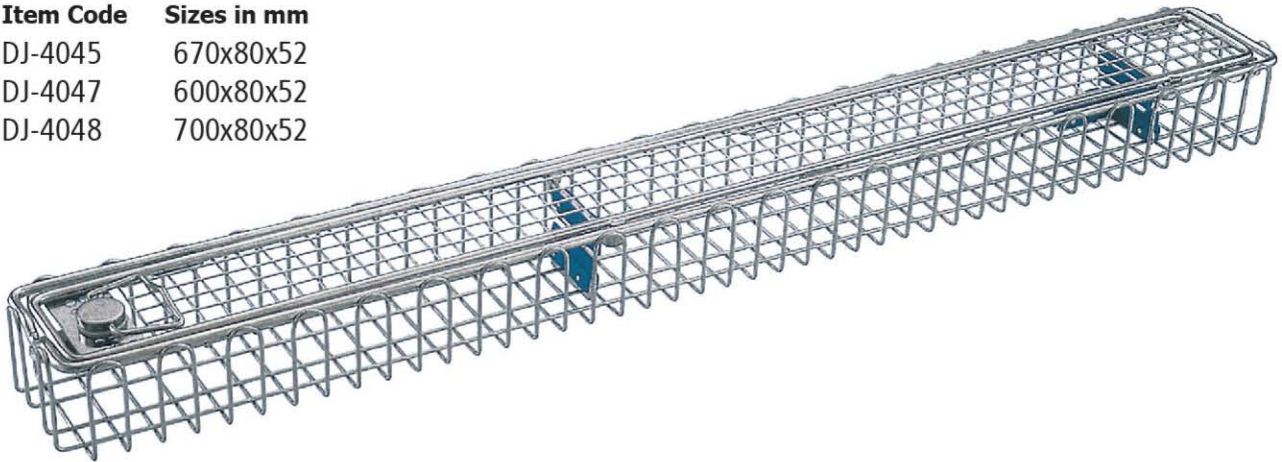

Item Code	Sizes in mm
DJ-4049	290x160x52



Item Code	Sizes in mm
DJ-4050	290x160x52



Item Code	Sizes in mm
DJ-4051	460x160x52



Item Code	Sizes in mm
DJ-4052	460x160x52

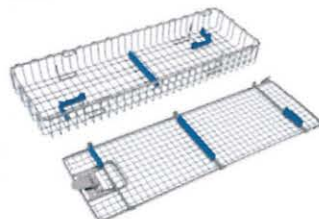

Item Code	Sizes in mm
DJ-4053	460x160x52



- Top and Lid frame wire diameter 5.0mm.
- Loops wire diameter 2.0mm.
- Autoclaveable silicon inserts.
- Electrolyte polish and burr free finish.
- Locking Clips

Endoscope Baskets

Endoscope Baskets provide the safety to costly endoscope during washing and sterilization processes. The silicon padding also provide protection to endoscope while handling and storage.

Item Code DJ-4054
Sizes in mm 310x150x77

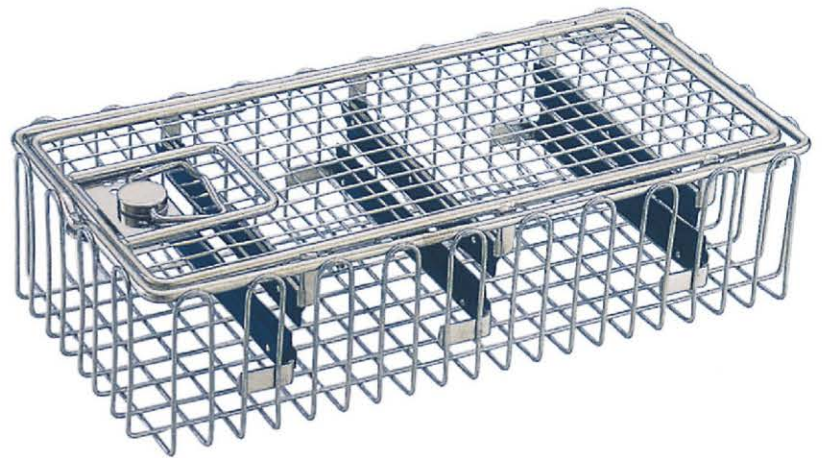

Item Code DJ-4066
Sizes in mm 460x225x52



Item Code DJ-4067
Sizes in mm 460x225x52

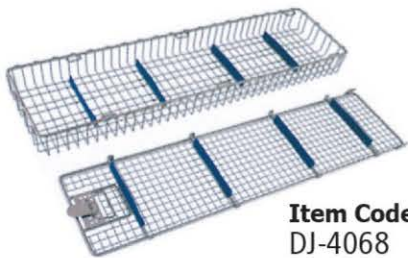

Item Code DJ-4068
Sizes in mm 580x160x52

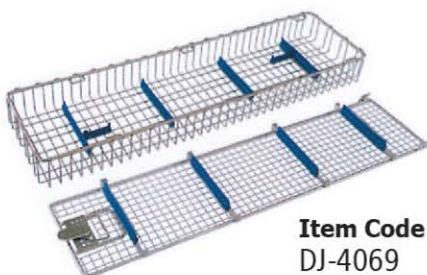

Item Code DJ-4069
Sizes in mm 580x160x52



Micro Ophthalmic Baskets

Micro ophthalmic baskets are specially designed for delicate micro instruments.

Item Code	Sizes in mm
DJ90-22000	240x250x38
DJ90-22001	480x250x38
DJ90-22002	400x250x38



- With silicon inserts on bottom of baskets to accommodate micro instruments.
- Lids are provided with silicon strips to grip the instruments.
- Side walls are made of perforated sheet.
- User friendly locking handle.

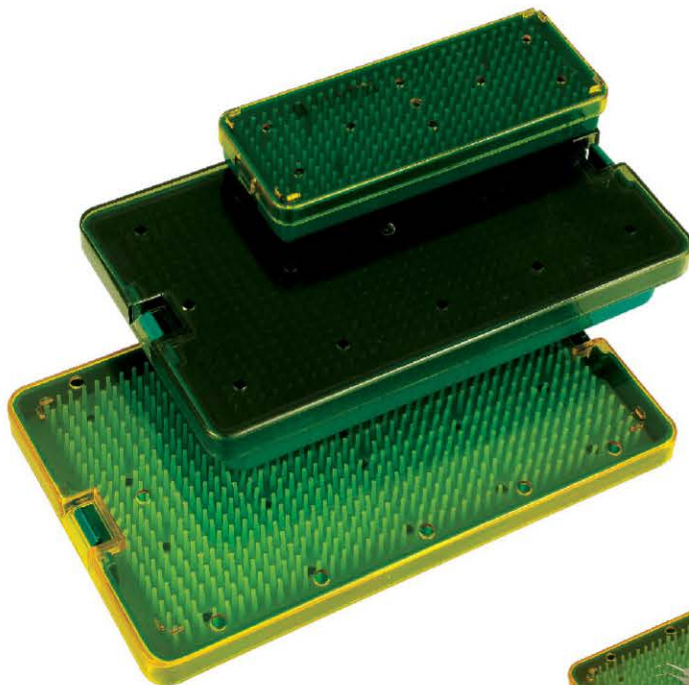

Plastic Autoclavable Tray

Item Code	Sizes in mm
D90-2020	160X70X25
D90-2030	265X160X25
D90-2040	265X160X50





Spring Holding Dental Cassette

Specially designed to minimize the contact area while locking of instruments inside the cassette. Each Instrument is held by separate spring. Further it can equally hold thicker and thinner instruments in one arrangement of cassette.

Item Code	Sizes in mm
DJ-4242	178X64x32
DJ-4243	178X114x32
DJ-4244	203X140x38
DJ-4245	203x280x38
DJ-4246	220x125x40
DJ-4247	250x220x40

Fine Mesh Dental Cassette

Fine Mesh dental cassette is much workable when instruments are required to be cleaned by all around water flow.



Item Code	Sizes in mm
DJ-4148	240X90x40
DJ-4149	235x80x30
DJ-4150	235x155x40



Item Code	Sizes in mm
DJ-3010	180X60X22
DJ-3011	180X125X22



Item Code	Sizes in mm
DJ-3012	184x145x34
DJ-3013	184x74x34
DJ-3014	184x74x34

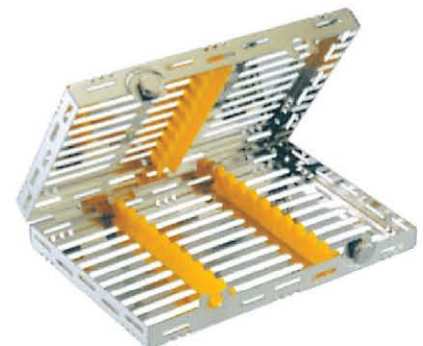

Item Code	Sizes in mm
DJ-3015	205x143x34

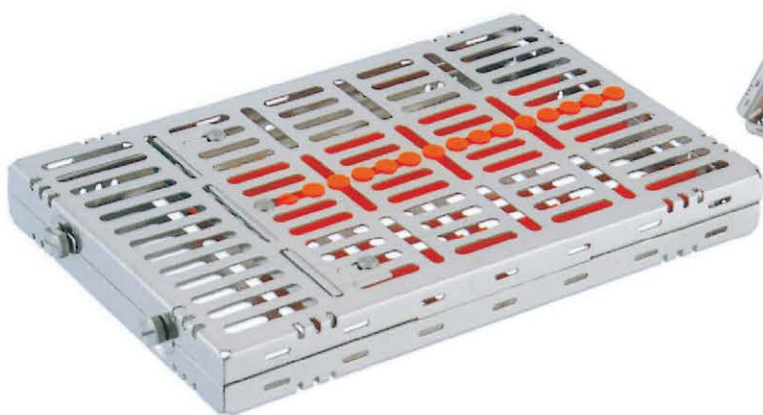

Item Code	Sizes in mm
DJ-3016	280x183x32

For 16 Instruments with partition plate

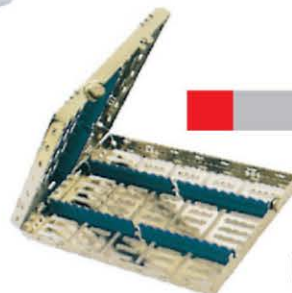

Item Code	Sizes in mm
DJ-3017	280x183x32

For 20 Instruments

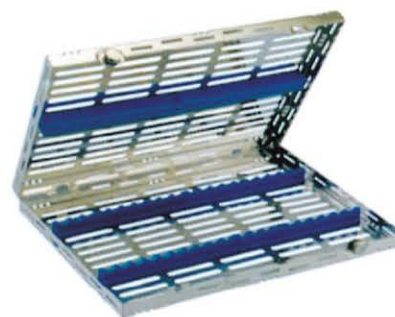

Item Code	Sizes in mm
DJ-3018	280x205x32



Item Code	Sizes in mm
DJ-3019	280x183x32

Silicon inserts available in different colors





Micro cassettes are the best for sterilization of micro instruments and small clamps.

Item Code	Sizes in mm
DJ-3040	40x55x20
DJ-3041	74x45x20
DJ-3042	74x59x24



Clip-IN

Item Code	Sizes in mm
DJ-3051	185x82x18
DJ-3052	185x140x18



Fixing Clamp

Our Fixing Clamps are:

- Adjustable clamp length.
- Universally adaptable for all sizes of instruments.
- Easily dismantled for cleaning purpose.

Item Code	Sizes in mm
DJ-4141	60/220x220x39
DJ-4142	60x220x39

Item Code	Sizes in mm
DJ-3060	180x148x50



Item Code	Sizes in mm
DJ-3061	100x90x50

Item Code	Sizes in mm
DJ-3062	100x90x50



- Implantology cassettes are strongly recommended for the process of cleaning and sterilization of implant accessories.
- Different silicon plugs and holders are helpful in holding different burs and drills of 2 to 6.5 mm.
- Special silicon arrangement to hold ratchet.
- A separate removable compartments for various micro parts.
- Lids are also available without perforation.

Item Code	Sizes in mm
DJ-3063	150x85x80



Item Code	Sizes in mm
DJ-3064	150x85x80



Item Code	Sizes in mm
DJ-3065	80x55x40



Item Code	Sizes in mm
DJ-3066	80x55x40



Item Code	Sizes in mm
DJ-3067	80x55x40

Bur Clips



Item Code DJ-3071
Sizes in mm 150x85x80

Item Code DJ-3072
Sizes in mm 150x85x80

Item Code DJ-3073
Sizes in mm 150x85x80



Bur Holder Stand



Item Code	Sizes in mm
DJ-3080	40x75x25 6 HOLES
DJ-3081	60x75x20 6 HOLES
DJ-3082	70x75x20 6 HOLES
DJ-3083	45x20x30 12 HOLES
DJ-3084	50x75x25 12 HOLES



Item Code	Sizes in mm
DJ-3090	45x20x30 4 HOLES
DJ-3091	35x25x30 6 HOLES
DJ-3092	45x25x30 8 HOLES
DJ-3093	63x25x30 12 HOLES
DJ-3094	85x25x30 16 HOLES
DJ-3095	110x35x34 30 HOLES

Instruments Trays



Item Code with Lid	Item Code without Lid	Sizes in mm
DJ-4837	DJ-4848	200x100x25MM
DJ-4838	DJ-4849	200x150x40MM
DJ-4839	DJ-4850	230x150x50MM
DJ-4840	DJ-4851	250x140x50MM
DJ-4841	DJ-4852	250x200x50MM
DJ-4842	DJ-4853	300x200x50MM
DJ-4843	DJ-4854	350x250x50MM
DJ-4844	DJ-4855	350x300x50MM
DJ-4845	DJ-4856	400x300x50MM
DJ-4846	DJ-4857	450x300x50MM

Instruments Box



Item Code	Sizes in mm
DJ-4858	150x80x40MM
DJ-4859	170x70x30MM
DJ-4860	180x80x40MM
DJ-4861	200x100x40MM
DJ-4862	230x120x50MM
DJ-4863	250x125x50MM
DJ-4864	300x150x50MM
DJ-4865	300x200x50MM
DJ-4866	350x175x65MM
DJ-4867	350x180x60MM

Kidney Tray (With Lid)

Item Code	Sizes in mm
DJ-4873	150
DJ-4874	180
DJ-4875	200
DJ-4876	250
DJ-4877	280



Kidney Tray (Without Lid)

Item Code	Sizes in mm
DJ-4878	150
DJ-4879	180
DJ-4880	200
DJ-4881	250
DJ-4882	280



Kidney Tray (Shallow Type)

Item Code	Sizes in mm
DJ-4883	170
DJ-4884	220
DJ-4885	240



Catheter Tray



Item Code	Sizes in mm
DJ-4868	250x75x40MM
DJ-4869	230x80x50MM
DJ-4870	300x80x40MM
DJ-4871	280x90x45MM
DJ-4872	440x100x50MM

Needle Cases



Item Code	Sizes in mm
DJ-4886	150x90x15
DJ-4886A	210x125x17



Item Code	Sizes in mm
DJ-4889	50x30x8
DJ-4890	65x45x8
DJ-4891	80x30x8



Item Code	Sizes in mm
DJ-4886C	65x15

Test Tube Stand

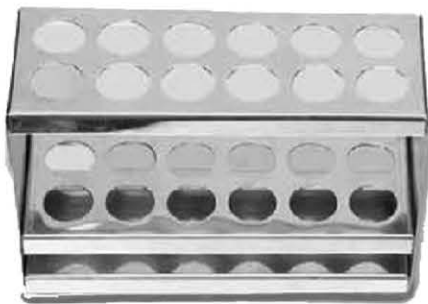

Item Code	Sizes in mm
DJ-4887	12 TUBES NOS

Endodontic Box



Item Code	Sizes in mm
DJ-4888	105x45x50

Dental Box



Item Code	Sizes in mm
DJ-4897	250x160x40

Scaler Trays



Item Code	Sizes in mm
DJ-4892	200x100
DJ-4893	205x115
DJ-4894	210x150
DJ-4895	220x130
DJ-4896	225x100

Bowls

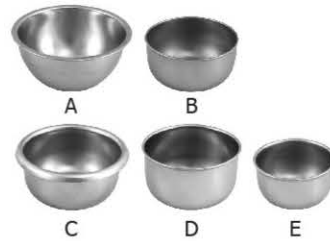

- (A) Wash Basin
- (B) Lotion Bowls
- (C) Bowl
- (D) Gallipots
- (E) Iodine Cup

(Available in all sizes)

Dressing Drum



Item Code	Sizes in mm
DJ-4898	80x80
DJ-4899	120x120
DJ-4900	130x290
DJ-4901	150x140
DJ-4902	160x120
DJ-4903	180x180
DJ-4904	200x190
DJ-4905	240x240
DJ-4906	290x240
DJ-4907	340x240
DJ-4908	390x200
DJ-4909	390x290
DJ-4910	390x390

Bed Pan

Slipper



Perfection



Item Code	Sizes in mm
DJ-4911	(Adult) Perfection
DJ-4912	(Child) Perfection
DJ-4913	(Adult) Slipper
DJ-4914	(Child) Slipper
DJ-4915	Fracture
DJ-4916	Chamber

Urinals

Item Code
DJ-4937



Urinal Jug
Standard Size

Item Code
DJ-4935



Male Urinal
Standard Size

Item Code
DJ-4936



Femal Urinal
Standard Size

Irrigators (Deuche Can)



Item Code	Sizes in mm
DJ-4917	1.0
DJ-4918	1.5
DJ-4919	2.0

Measuring Jug



Item Code	Sizes in mm
DJ-4925	250 ML
DJ-4926	500 ML
DJ-4927	1000 ML

Holding Pins

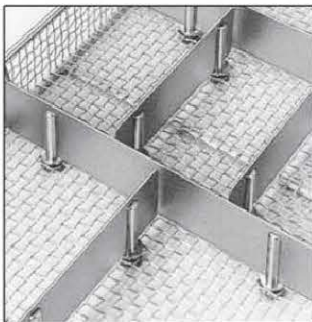

Holding Pins For Instruments

DJ-4920



Holding Pins For Partition Sheets

DJ-4935

Spirit Lamp



Item Code	Sizes in mm
DJ-4921	Single
DJ-4922	Double

Stainless Steel Tags



Item Code	Sizes in mm
DJ-4923	50x25MM
DJ-4924	75x30 MM



Item Code	Sizes in mm
DJ-4932	90x50 MM
DJ-4933	90x35 MM

Silicone Pin Mat



Item Code	Sizes in mm
DJ-4928	500x300
DJ-4929	480x250

Universal Silicon Holders



Item Code	Sizes in mm
DJ-4904	250x35x10



Item Code	Sizes in mm
DJ-4905	250x35x10

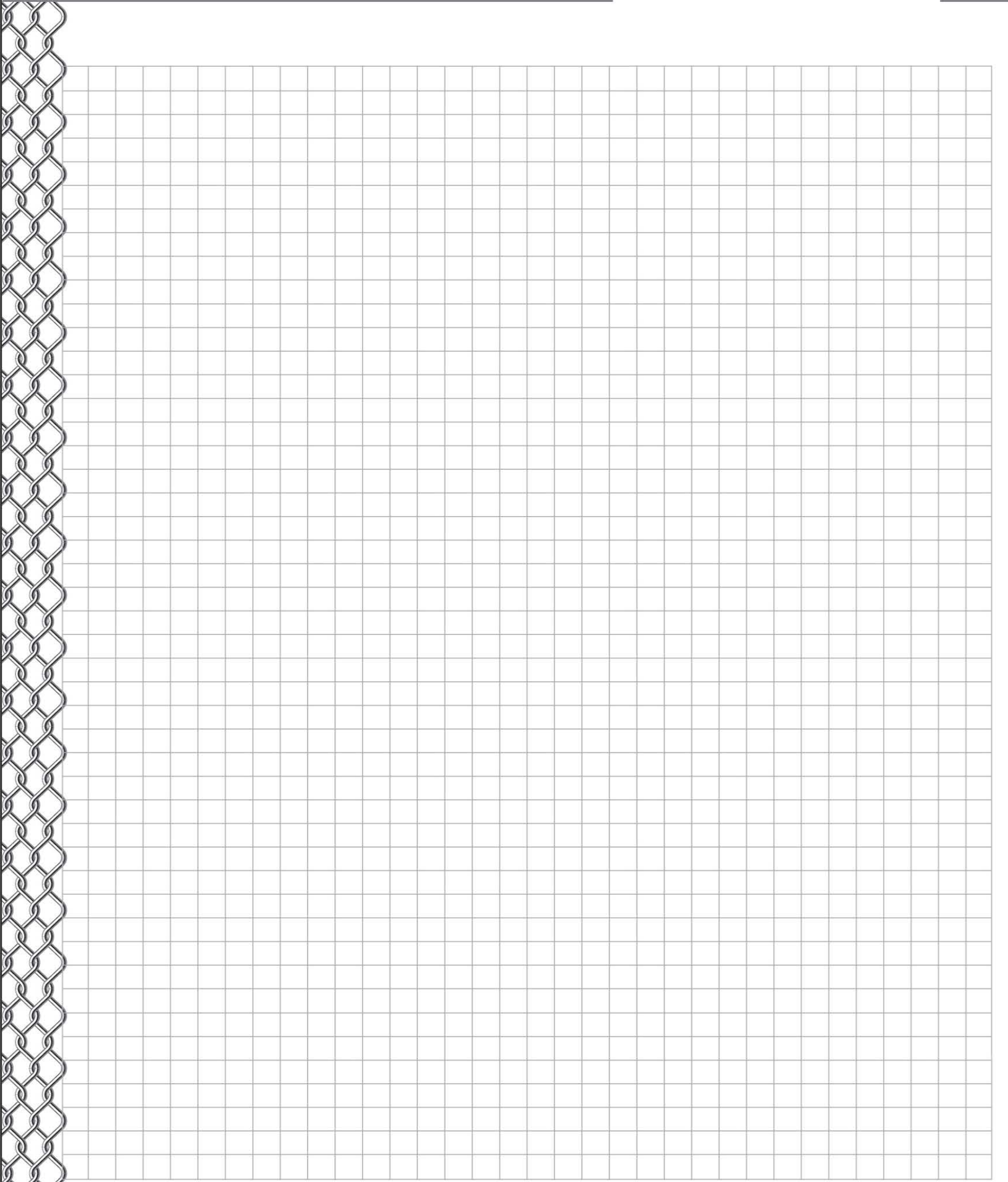

Factory:

A Gulshin Street # 1, Nishat Park,
Paris Road, Sialkot -1, 51310,
Pakistan, Opp SCCI & Building.

T +92 52 4270717
+92 52 4270818
+92 52 4273616

F +92 52 4270616

E info@daudjee.com

E info@daudjeemfg.com

W www.daudjeemfg.com

www.daudjee.com

ISO - 9001 - 2008,
ISO - 13485: 2003

